

# V5050

## LED Whip Mast Luminaire LED-Peitschenmastleuchte

**Vulkan**  
Nordeonbrand

Installation Instructions · Montageanleitung · Notice de montage · indicaciones de montaje · Istruzioni per l'installazione · Installatie-instructies

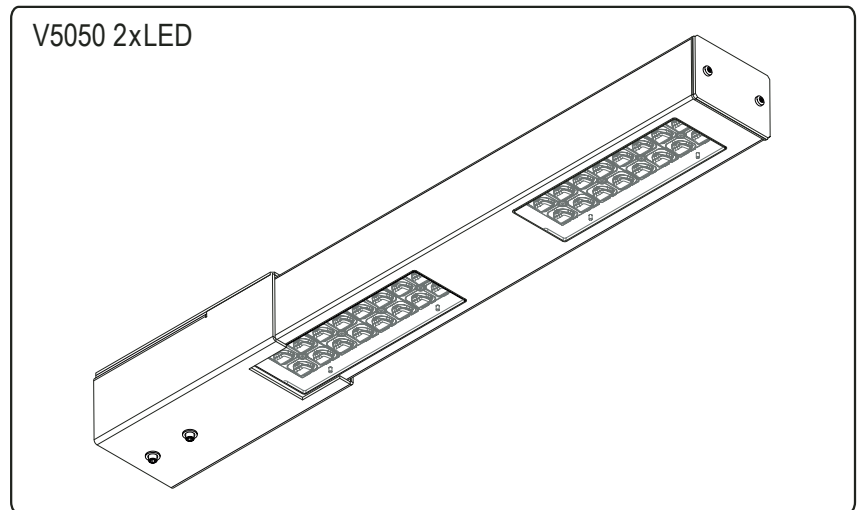
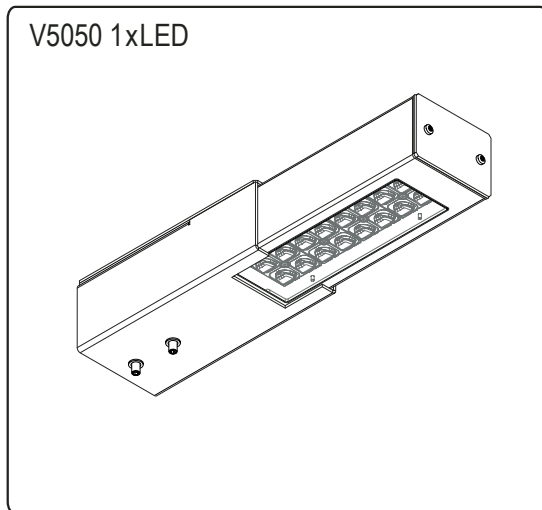

	<b>IP 65</b>	<b>CE</b>	<b>230 V</b> <b>50 Hz</b>	
<b>V5050 1xLED</b> 3,0 kg	<b>V5050 2xLED</b> 5,7 kg	<b>IK 10</b>		

Max. qty. of V5050 on MCB 16A, type-B  
Max. Anzahl V5050 LED-Leuchten an einem MCB 16A, Typ-B

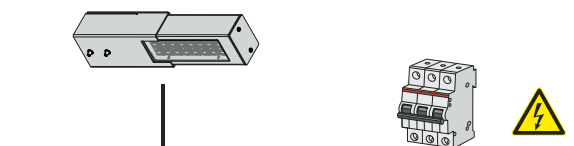

Inrush Current: max. x / y  $\mu$ s @ 230V  
Einschaltstrom: max. x / y  $\mu$ s @ 230V

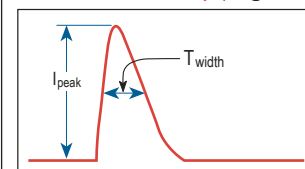

Max. drivers on MCB (16 A type-B): max. z  
Max. Treiber MCB (16 A Typ-B): max. z

Luminaire Leuchte	Driver Treiber	x Inrush current (I <sub>peak</sub> ) Einschaltstromspitze	y Inrush current width (T) Einschaltstromlänge	z MCB 16 A Typ B
V5050 1xLED	40 W	max. 22 A	290 $\mu$ s	20 Stk.
V5050 2xLED	75 W	max. 46 A	250 $\mu$ s	11 Stk.



### General safety notes Allgemeine Sicherheitshinweise

- GB** - Installation/maintenance only by skilled personnel.  
- Use luminaires only with complete protection covers!  
- During overhaul/maintenance only use original parts.  
- The light source contained in this luminaire shall only be replaced by the manufacturer or his service agent or a similar qualified person.  
- If any luminaire is subsequently modified, the person responsible for the modification shall be considered the manufacturer.  
- The manufacturer bears no liability for damage caused by inappropriate use or application.
- D** - Montage/Wartung nur durch Fachkräfte.  
- Die Leuchte darf nur mit ihren vollständigen Schutzabdeckungen betrieben werden!  
- Bei Instandsetzung/Instandhaltung nur Originalteile verwenden.  
- Die Lichtquelle dieser Leuchte darf nur vom Hersteller oder einem von ihm beauftragten Servicetechniker oder einer vergleichbar qualifizierten Person ersetzt werden.  
- Werden nachträglich Änderungen an Leuchten vorgenommen, so gilt derjenige als Hersteller, der diese Änderung vornimmt.  
- Der Hersteller übernimmt keine Haftung für Schäden, die durch unsachgemäßen Einsatz entstehen.

Nordeon GmbH  
Rathenaustraße 2-6  
D-31832 Springe  
Germany  
Phone +49(0)5041 75 0  
www.nordeon.com/www.vulkan.eu

## Dimensions/Abmessungen

V5050 1xLED

Wind projecting surface/Windangriffsfläche:  $A_w = 0,04 \text{ m}^2$

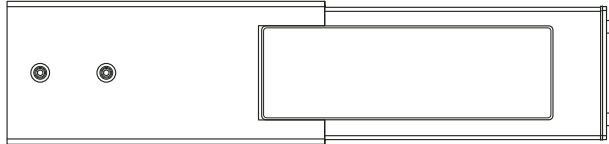
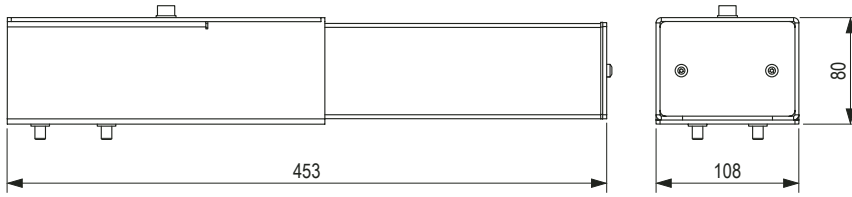

Dimensions [mm]

V5050 2xLED

Wind projecting surface/Windangriffsfläche:  $A_w = 0,06 \text{ m}^2$

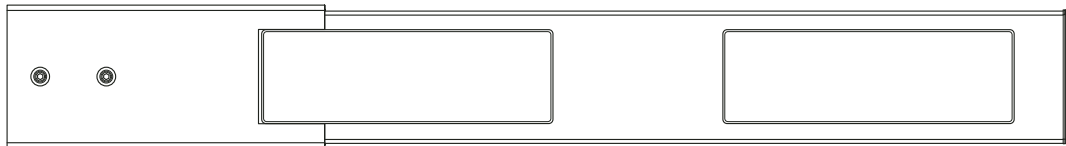
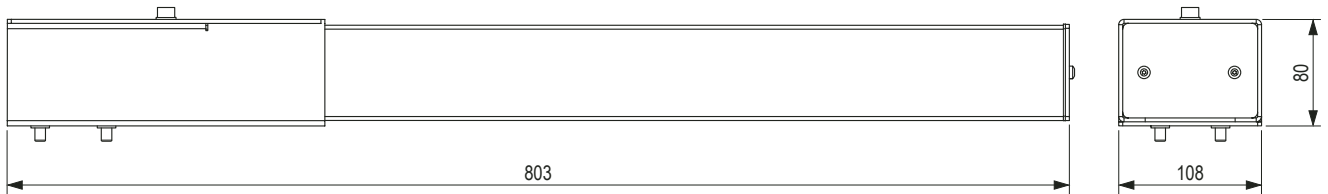

Dimensions [mm]

# Mounting/Montage

1.

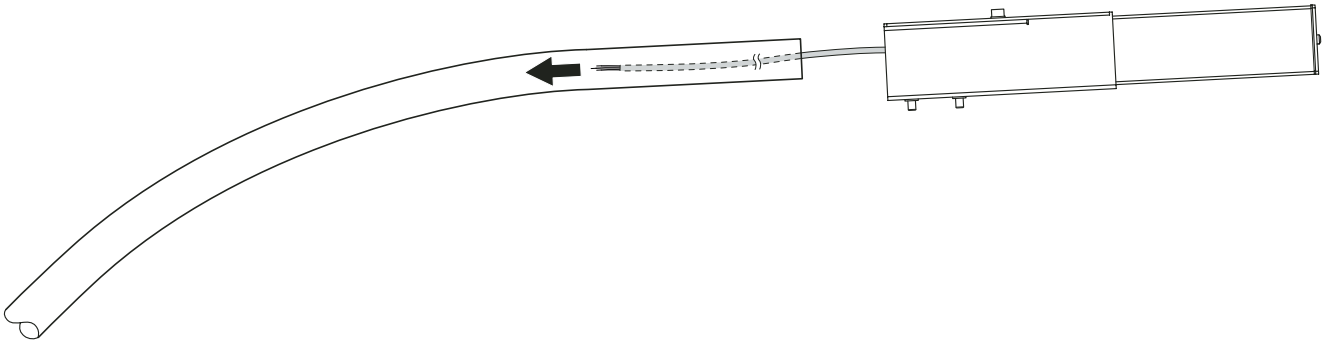

2.

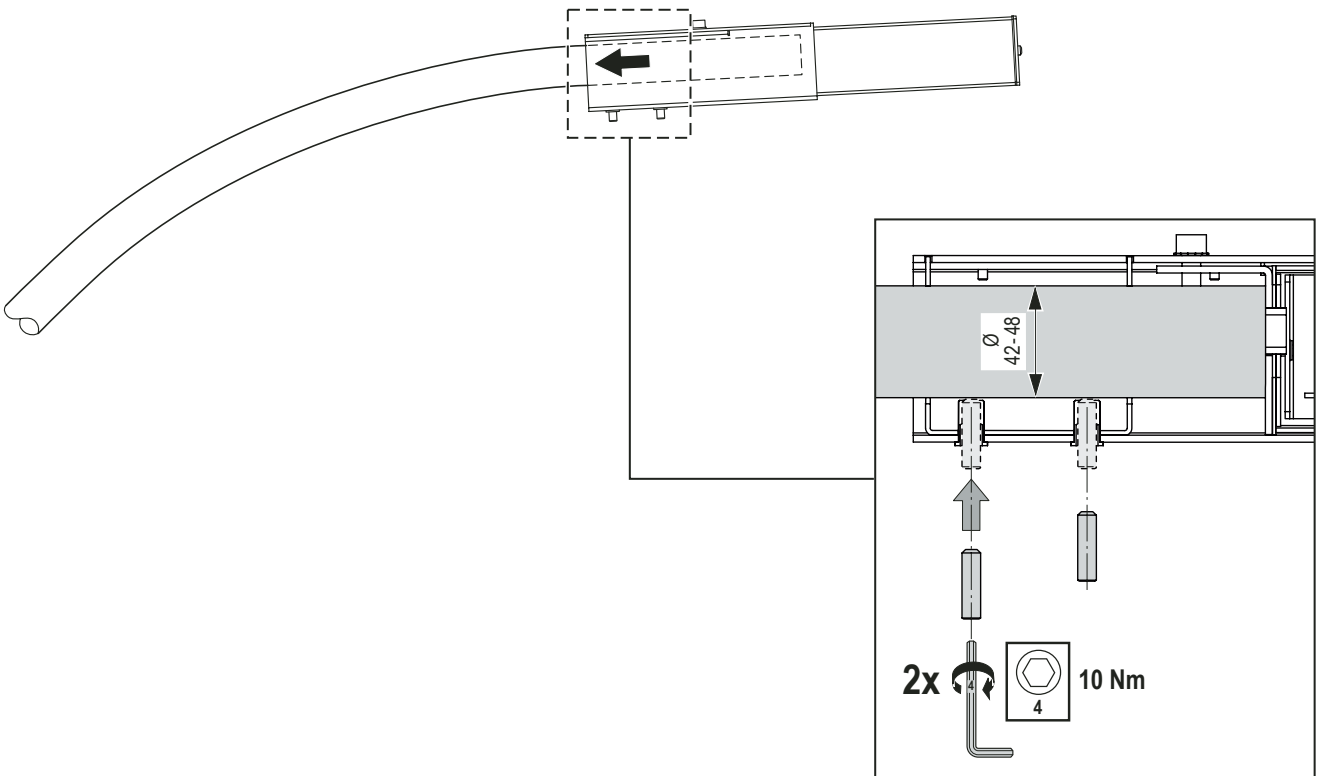

# Electrical connection/Elektrischer Anschluss

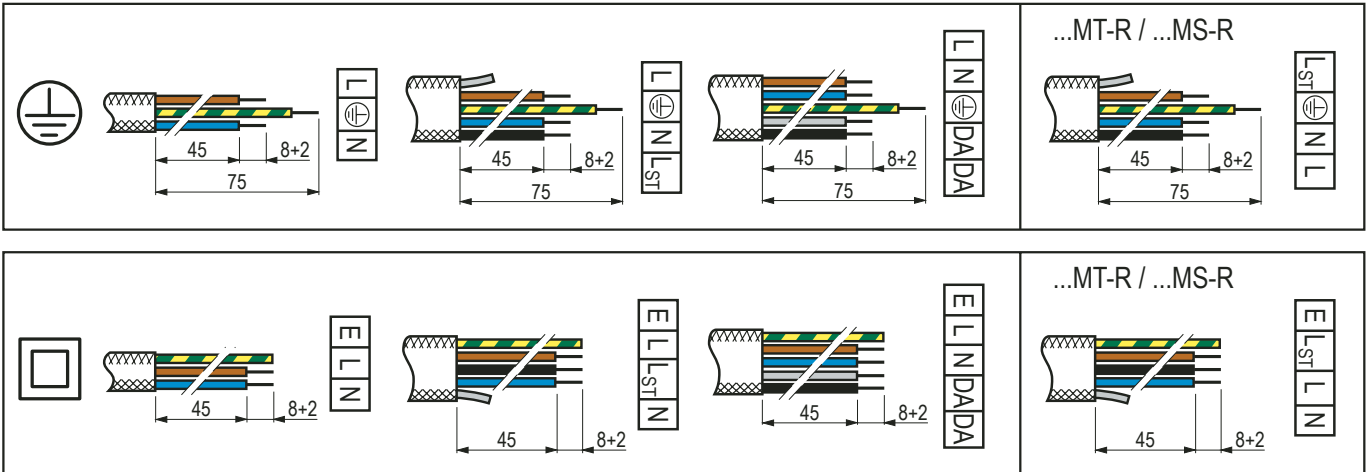

L = max. load / Ganznacht, L<sub>ST</sub> = power reduction / Halbnacht

## LRA - Light regulation antarkic / Autarke Lichtsteuerung

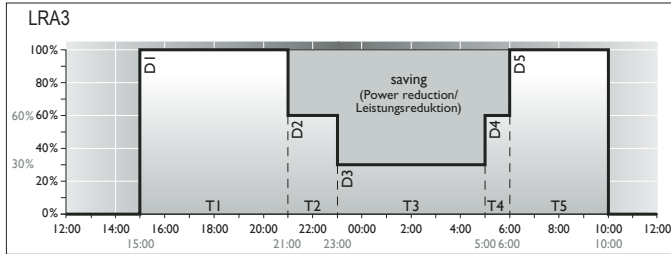
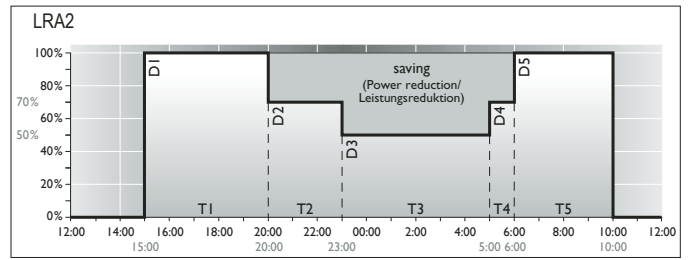
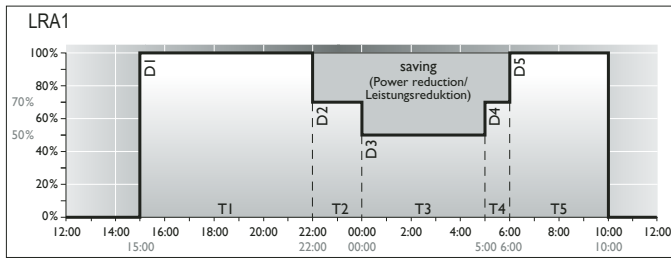

## LRT - Light regulation twin phases / Leistungsreduzierung mit Steuerphase

